

RIVA GROUPE  
CATALOGUE  
HOSPITAL

**Riva**  
Groupe

[www.riva-office.fr](http://www.riva-office.fr)

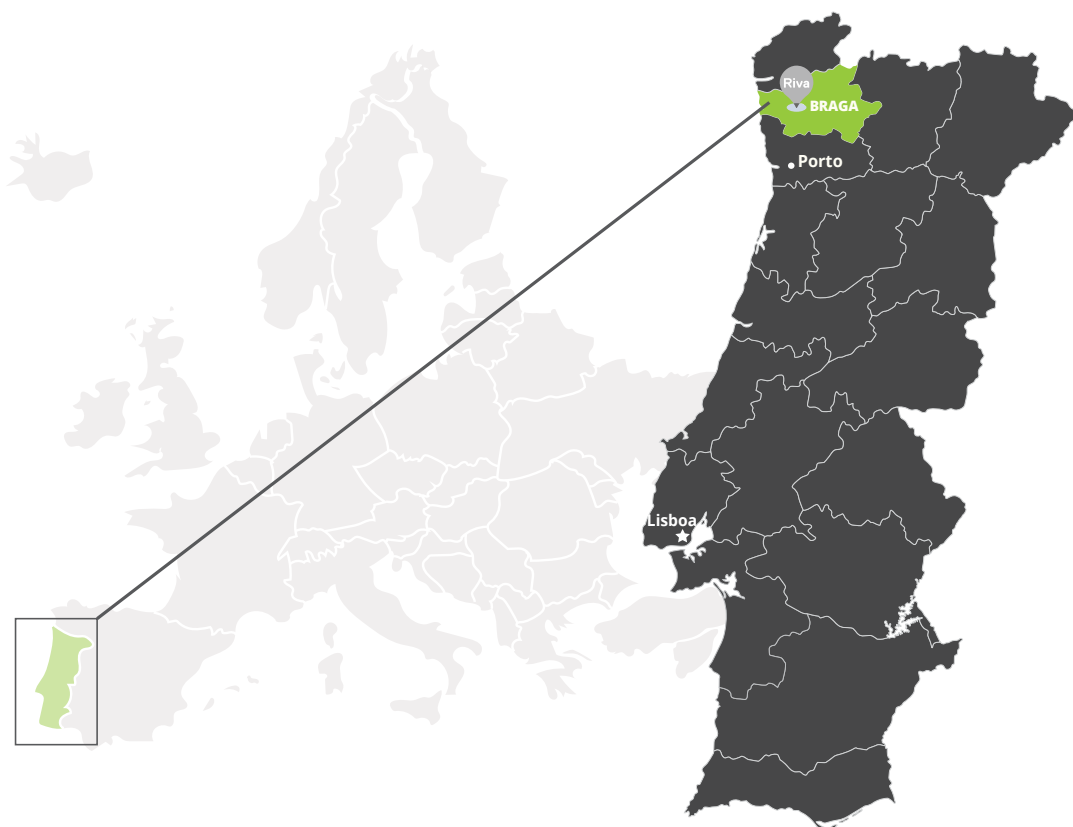



## QUI SOMMES-NOUS...

WHO WE ARE... / QUEM SOMOS...

FR/EN/PT

Entreprise portugaise avec plus de 25 ans d'expérience, spécialisée dans la fabrication et commercialisation de meubles de bureau et de maison sur mesure.

Portuguese company with over 25 years of experience, specialized in office and home furniture.

Empresa Portuguesa com mais de 25 anos de experiência, especializada no fabrico e comércio de mobiliário de escritório e casa.



MADE IN PORTUGAL



EXPORTATION À ÉCHELLE MONDIALE  
WORLDWIDE EXPORT /  
EXPOERTAÇÃO PARA TODO O MUNDO



SUR MESURE  
CUSTOM / À MEDIDA



SOLUTIONS DE MEUBLES  
FURNITURE SOLUTIONS /  
SOLUÇÕES MOBILIÁRIO



[www.riva-office.fr](http://www.riva-office.fr)

Rua Pomar de Marvila, Lote 13  
Parque Industrial de Sequeira  
4705-629 / Braga - Portugal

+33(0) 187 449 733 / [info@riva-office.fr](mailto:info@riva-office.fr)



# FUNCTIONAL HOSPITAL BED



## Multi-function electric ICU bed SMB-2001



Electric 15 functions Medical bed  
Size 1060x520/780mm(LxWxH)

### Option:

- ※ Steel bed surface
- ※ lifting pole
- ※ Foot switch

### Standard device:

- 1Pair head and foot boards
- 4Pcs European style long bedside rails
- 2Pcs lifting columns actuators and 3pcs actuators
- 1Pc touch screen control
- 2Pcs built – in bedside rail control
- 4Pcs angle display devices
- 4Pcs 6" central locking castors
- 4Pcs braking pedals on four corners
- 4Pcs bumpers
- 4Pcs IV drip holes
- 4Pcs drainage bag hooks

### Function:

- Back section up&down
- Knee section up&down
- The whole bed up&down
- Trendelenburg and reverse trendelenburg
- Left and right bedside turn-over
- Complete X-ray filming function
- Back section decompression function
- Manual CPR function
- One-Key CPR function
- One-Key cardiac chair function
- One-Key trendelenburg function
- Extensible bed end
- UPS

## Five function electric hospital bed SMB-2002



Electric 15 functions Medical bed  
Size 1060x520/780mm(LxWxH)



### Accessories:

- 1) I.V. pole
- 2) Integrated bedside table\*
- 3) 6 pcs mattress holder\*
- 4) X-RAY ready\*
- 5) Expand 150mm\*

### Dimensions:

- 1) L2220\* W1040 \*H500-900mm
- 2) Angle of back section 0 ~ 70° (± 5° )
- 3) Angle of leg section: 0 ~ 40° (± 5° )
- 4) Angle of Trendelenburg and Reverse Trendelenburg: 0 ~ 13° (± 2° )



### Five function electric hospital bed

#### Features:

- 1) Cold steel plate wholly molded surface, integrated frame treated with electrostatic spraying. Anti-aging and anti-rust
- 2) PE head and foot board integrated with bedside table\*
- 3) 4 pcs longer automatic lifting railing, safe and reliable, and can be fixed upward and downward
- 4) One set of handset
- 5) Manual CPR\*
- 6) Battery backup
- 7) Four wheels adopt central control system
- 8) Degree show function
- 9) Foot section correct to horizontal position
- 10) Back section decompression function, more space for patients

## Five function electric hospital bed SMB-2003

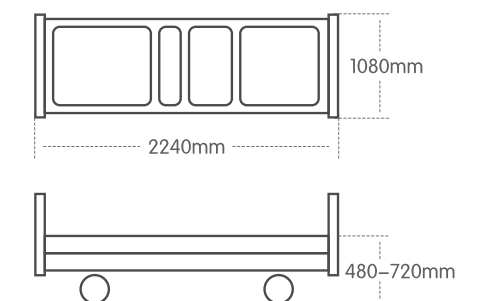

### Accessories:

- 1) I.V.pole
- 2) Wheels
- 3) Automatic lifting railing

### Dimensions:

- 1) Size: L2240 × W1080 × H480-720mm
- 2) Angle of back section: 0 ~ 60° (± 5° )
- 3) Angle of leg section: 0 ~ 30° (± 5° )
- 4) Angle of Trendelenburg and reverse Trendelenburg: 0 ~ 13° (± 2° )
- 5) Adjustable height: 480-720mm

### Features:

- 1) Cold steel plate wholly molded surface, connected with arc soft join.
- 2) Streamline headboard and banister of PP.
- 3) 4pcs electro-motor, 1pc control box, 1pc handset
- 4) Automatic lifting railing, safe and reliable, and can be fixed upward and downward
- 5) One set of handset
- 6) Four wheels adopt central control system, which is stable and reliable

## Multi-function electric weighting care bed SMB-2004



Electric 15 functions Medical bed  
Size 1060x500/800mm(LxWxH)



### Option:

- ✘ Back section X-ray filming function
- ✘ Extensible bed end
- ✘ lifting pole
- ✘ Roll-over function of left and right side of bed surface
- ✘ Left and Right Inclination Function of the Whole Bed

### Standard device:

- 1Pair head and foot boards
- 4Pcs European style long bedside rails
- 2Pcs built-in bedside rail control
- 4Pcs actuators
- 1Pc handset
- 4Pcs angle display devices
- 4Pcs 5" central locking castors
- 2Pcs braking pedals on both sides
- 4Pcs bumpers
- 4Pcs IV drip holes
- 4Pcs drainage bag hooks
- 2Pcs lifting pole holes

### Function:

- Back section up&down
- Knee section up&down
- The whole bed up&down
- Trendelenburg and reverse trendelenburg
- Scale function
- Back section decompression function
- One-Key trendelenburg function
- UPS
- One-Key CPR function
- Manual CPR function

## Five function electric hospital bed with ACP SMB-2005



Electric 15 functions Medical bed  
Size 1060x520/780mm(LxWxH)



### Accessories:

- 1) I.V.pole
- 2) Wheels
- 3) Longer Automatic lifting railing

### Dimensions:

- 1) Size: L2260 × W1080 × H480–720mm
- 2) Angle of back section: 0 ~ 60° (± 5° )
- 3) Angle of leg section: 0 ~ 30° (± 5° )
- 4) Angle of Trendelenburg and reverse Trendelenburg: 0 ~ 13° (± 2° )
- 5) Adjustable height: 480–720mm

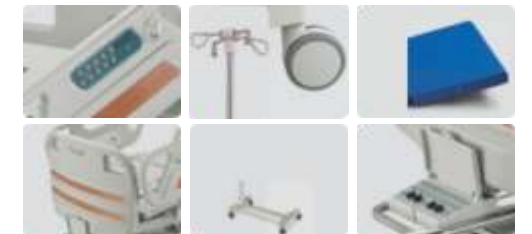

### Features:

- 1) Cold steel plate wholly molded surface, connected with arc soft join.
- 2) PE head and foot board, longer automatic lifting railing, safe and reliable, and can be fixed upward and downward.
- 3) 4pcs Longer Automatic lifting railing embed design handset, can be fixed upward and downward, provides raises and lowers the upper body, knees, bed-frame height, Trendelenburg and reserve Trendelenburg.
- 4) The ACP (Attendant Control Panel) is fitted at end of bed It allows the nursing staff to retain direct control over critical functions.
- 5) 4pcs electro-motor, 1pc control box, 1pc ACP
- 6) Four wheels adopt central control system, which is stable and reliable

## Five function electric bed SMB-2006



Electric 15 functions Medical bed  
Size 2260x1060x430/720mm (LxWxH)

### Option:

- ✘ Back section X-ray filming function
- ✘ Manual CPR function
- ✘ UPS

### Function:

- Back section up&down
- Knee section up&down
- The whole bed up&down
- Trendelenburg and reverse trendelenburg
- Back section decompression function

### Standard device:

- Head and tail plate 1 pair
- 4Pcs European style long bedside rails
- 2Pcs built – in bedside rail control
- 4Pcs actuators
- 1Pc handset
- 4Pcs angle display devices
- 4Pcs 5" central locking castors
- 2Pcs braking pedals on both sides
- 4Pcs IV drip holes
- 4Pcs drainage bag hooks

## Five Function Electric hospital bed SMB-2007



### Dimensions:

- 1) L2220\* W1040 \*H460-700mm
- 2) Angle of back section 0 ~ 70° (± 5° )
- 3) Angle of leg section: 0 ~ 30° (± 5° )
- 4) Angle of Trendelenburg and Reverse Trendelenburg: 0 ~ 13° (± 2° )

### Accessories:

- 1) I.V. pole
- 2) Integrated bedside table\*
- 3) 6 pcs mattress holder\*
- 4) X-RAY ready\*
- 5) Expand 150mm\*

### Features:

- 1) Cold steel plate wholly molded surface, integrated frame treated with electrostatic spraying. Anti-aging and anti-rust
- 2) PE head and foot board integrated with bedside table\*
- 3) 4 pcs longer automatic lifting railing, safe and reliable, and can be fixed upward and downward
- 4) One set of handset
- 5) Manual CPR\*
- 6) Battery backup
- 7) Four wheels adopt central control system
- 8) Degree show function
- 9) Foot section correct to horizontal position
- 10) Back section decompression function , more space for patients

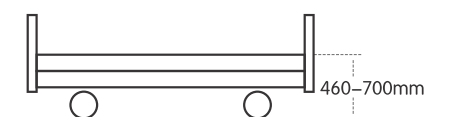
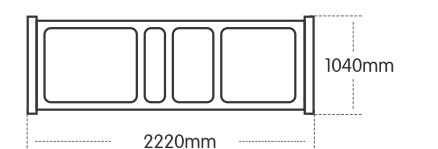

**(a) Five function electric bed**  
**SMB-2008**



Electric 15 functions Medical bed  
 Size 2260x1060x430/720mm (LxWxH)

**Option:**

- ※ CPR function
- ※ UPS
- ※ 2Pcs built-in bedside rail control

**Function:**

- Back section up&down
- Knee section up&down
- The whole bed up&down
- Trendelenburg and reverse trendelenburg

**Standard device:**

- 1Pair head and foot boards
- 4Pcs European style length bedside rails
- 4Pcs motors
- 1Pc handset
- 2Pcs angle display devices
- 4Pcs 5" central locking castors
- 2Pcs braking pedals on both sides
- 4Pcs bumpers
- 4Pcs IV drip holes
- 4Pcs drainage bag hook

**Five Function Electric hospital bed**  
**SMB-2009**



**Dimensions:**

- 1) Size: L2160 x W1080 x H480-720mm
- 2) Angle of back section: 0 ~ 60° (± 5° )
- 3) Angle of leg section: 0 ~ 30° (± 5° )
- 4) Angle of Trendelenburg and reverse Trendelenburg: 0 ~ 13° (± 2° )
- 5) Adjustable height: 480-720mm

**Accessories:**

- 1) I.V pole
- 2) Wheels
- 3) Longer Automatic lifting railing

**Features:**

- 1) Cold steel plate wholly molded surface.
- 2) Streamline headboard and long banister of PE.
- 3) 4pcs electro-motor, 1pc control box, 1pc handset
- 4) Automatic lifting guardrail, safe and reliable, and can be fixed upward and downward
- 5) One set of handset
- 6) Four castors adopt central control system, which stable and reliable.

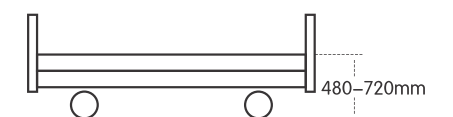
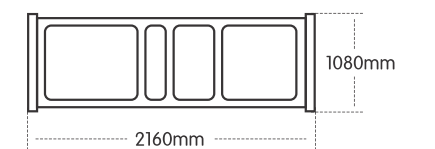

## Five Function Electric hospital bed SMB-2010



### Dimensions:

- 1) Size: L2130 × W980 × H480-720mm
- 2) Angle of back section: 0 ~ 70° (± 5° )
- 3) Angle of leg section: 0 ~ 30° (± 5° )
- 4) Angle of Trendelenburg and reverse Trendelenburg: 0 ~ 13° (± 2° )
- 5) Adjustable height: 480-720mm

### Accessories:

- 1) I.V.pole
- 2) Wheels
- 3) Aluminum alloy protective railing

### Features:

- 1) Cold steel plate wholly molded surface.
- 2) Integrated stamping frame and treated with electrostatic spraying, anti-aging and anti-rust
- 3) ABS bed head, 6 aluminum bars fence can go up and down.
- 4) 4pcs electro-motor, 1pc control box,
- 5) One set of handset
- 6) 5" universal castors
- 7) Max Loading: 280 Kg
- 8) Battery backup

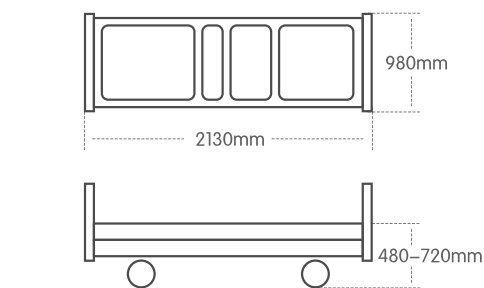

## Three function electric bed SMB-2011



Electric 15 functions Medical bed  
Size 2260x1060x430/720mm

### Option:

- ※ UPS
- ※ CPR function
- ※ 2Pcs built-in bedside rail control

### Function:

- Back section up&down
- Knee section up&down
- The whole bed up&down
- Back section decompression function

### Standard device:

- 1Pair head and foot boards
- 4Pcs European style long bedside rails
- 3Pcs motors
- 1Pc handset
- 2Pcs angle display devices
- 4Pcs 5" central locking castors
- 2Pcs braking pedals on both sides
- 4Pcs bumpers
- 4Pcs IV drip holes
- 4Pcs drainage bag hook



## Luxury three crank hospital bed SMB-2012



### Dimensions:

- 1) Size: L2180 × W1040 × H460-700mm
- 2) Angle of back section: 0 ~ 70° (± 5°)
- 3) Angle of leg section: 0 ~ 40° (± 5°)
- 4) Adjustable height: 460-700mm

### Accessories:

- 1) I.V. pole
- 2) Four center-control castors
- 3) Automatic lifting railing

### Features:

- 1) 3sets manual crank system. ABS bed head board. Cold steel plate wholly molded surface
- 2) Automatic long and short lifting guardrail, safe and reliable, and can be fixed upward and downward
- 3) Four truckles adopt central control system, which is stable and reliable, 2pcs urine hooks, 6pcs IV drip holes
- 4) Integrated stamping frame and treated with electrostatic spraying, anti-aging and anti-rust
- 5) Max Loading: 280 Kg

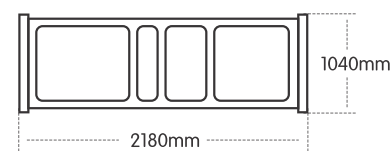

## (b) Three function electric bed SMB-2013



### Option:

- ※ ABS Central control pedal
- ※ Stainless steel centrally controlled brake
- ※ UPS
- ※ 1 telescopic dining board

Size 2160x980x430/720mm(LxWxH)

CBM 1.0

### Standard device:

- 1Pair head and foot boards
- 4Pcs European style length bedside rails
- 3Pcs motors
- 1Pc handset
- 2Pcs angle display devices
- 4Pcs 5" central locking castors
- 2Pcs braking pedals on both sides
- 4Pcs bumpers
- 4Pcs IV drip holes
- 4Pcs drainage bag hook

## Three Function Electric hospital bed SMB-2014



### Dimensions:

- 1) Size: L2130 × W980 × H480–720mm
- 2) Angle of back section: 0 ~ 70° (± 5° )
- 3) Angle of leg section: 0 ~ 30° (± 5° )
- 4) Adjustable height: 480–720mm

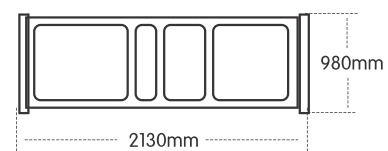

### Accessories:

- 1) I.V. pole
- 2) Wheels
- 3) Aluminum alloy protective railing

### Features:

- 1) Cold steel plate wholly molded surface.
- 2) Integrated stamping frame and treated with electrostatic spraying, anti-aging and anti-rust
- 3) ABS bed head, 6 aluminum bars fence can go up and down.
- 4) 3pcs electro-motor, 1pc control box,
- 5) One set of handset
- 6) Four wheels adopt central control system, which is stable and reliable
- 7) Max Loading: 280 Kg
- 8) Battery backup

## Three Function Electric hospital bed SMB-2015



### Dimensions:

- 1) Size: L2180 × W1040 × H460–700mm
- 2) Angle of back section: 0 ~ 80° (± 5° )
- 3) Angle of leg section: 0 ~ 40° (± 5° )
- 4) Adjustable height: 460–700mm

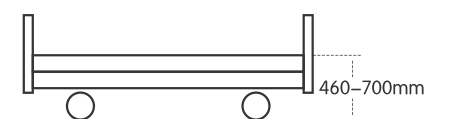
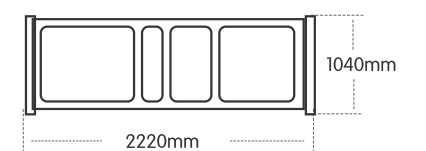

### Accessories:

- 1) I.V. pole
- 2) Wheels
- 3) Steel protective railing

### Features:

- 1) Cold steel plate wholly molded surface.
- 2) Integrated stamping frame and treated with electrostatic spraying, anti-aging and anti-rust
- 3) ABS bed head, 6 steel bars fence can go up and down.
- 4) 3pcs electro-motor, 1pc control box,
- 5) One set of handset
- 6) Four truckles adopt central control system, which is stable and reliable
- 7) Max Loading: 280 Kg
- 8) Battery back up

## Three Function Electric hospital bed SMB-2016



### Dimensions:

- 1) Size: L2260 × W1080 × H480-720mm
- 2) Angle of back section: 0 ~ 60° (± 5°)
- 3) Angle of leg section: 0 ~ 30° (± 5°)
- 4) Adjustable height: 480-720mm

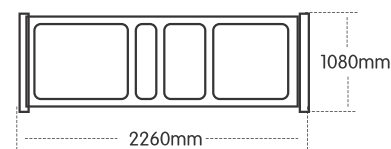

### Accessories:

- 1) I.V. pole
- 2) Wheels
- 3) Automatic lifting railing

### Features:

- 1) Cold steel plate wholly molded surface, connected with arc soft join.
- 2) Streamline headboard and banister of PE.
- 3) 3pcs electro-motor, 1pc control box, 1pc handset
- 4) Automatic Long and Short lifting railing, safe and reliable, and can be fixed upward and downward
- 5) One set of handset
- 6) Four wheels adopt central control system, which is stable and reliable

## Three Function Electric hospital bed SMB-2017



### Dimensions:

- 1) Size: L2130 × W980 × H480-720mm
- 2) Angle of back section: 0 ~ 70° (± 5°)
- 3) Angle of leg section: 0 ~ 30° (± 5°)
- 4) Adjustable height: 480-720mm

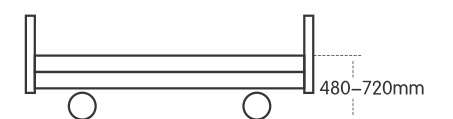
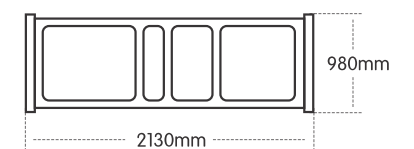

### Accessories:

- 1) I.V. pole
- 2) Wheels
- 3) Aluminum alloy protective railing

### Features:

- 1) Cold steel plate wholly molded surface.
- 2) Integrated stamping frame and treated with electrostatic spraying, anti-aging and anti-rust
- 3) ABS bed head, 6 aluminum bars fence can go up and down.
- 4) 3pcs electro-motor, 1pc control box,
- 5) One set of handset
- 6) 5" universal castors
- 7) Max Loading: 280 Kg
- 8) Battery backup

## Extra Low Three Function Electric bed SMB-2018



### Dimensions:

- 1) Size: L2130mm x W980mm x H320mm~620mm
- 2) Angle of back section: 0 ~ 70° (± 5° )
- 3) Angle of leg section: 0 ~ 30° (± 5° )
- 4) Adjustable height: 320~620mm

### Accessories:

- 1) I.V.pole
- 2) Wheels
- 3) Aluminum alloy protective railing

### Features:

- 1) Cold steel plate wholly molded surface.
- 2) Integrated stamping frame and treated with electrostatic spraying, anti-aging and anti-rust
- 3) ABS bed head, 6 aluminum bars head fence can go up and down.
- 4) 3pcs electro-motor, 1pc control box,
- 5) Battery backup
- 6) One set of handset
- 7) 5" universal castors
- 8) Max Loading: 280 Kg

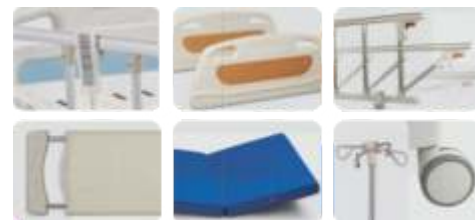
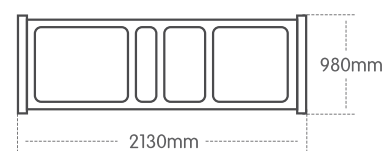

## (a) Two function electric bed SMB-2019



### Function:

- Back section up&down
- Knee section up&down

### Option:

- ※ UPS
- ※ 4 New Europe Long and Long Composite Guardrails
- ※ Dust cover 1

Size 2220x1060x500mm(LxWxH)  
CBM 1.0

### Standard device:

- 1Pair head and foot boards
- 4Pcs European short combination guardrail
- 2Pcs motors
- 1Pc handset
- 2Pcs angle display devices
- 4Pcs 5" central locking castors
- 1Pc pedal in the middle
- 4Pcs bumpers
- 4Pcs IV drip holes
- 4Pcs drainage bag hook

## Two Function Electric Hospital Bed SMB-2020



### Dimensions:

- 1) Size: L2260 × W1040 × H500mm
- 2) Angle of back section: 0 ~ 70° (± 5°)
- 3) Angle of leg section: 0 ~ 30° (± 5°)

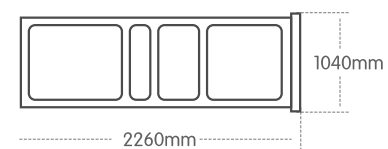

### Accessories:

- 1) I.V. pole
- 2) Wheels
- 3) Aluminum alloy protective railing

### Features:

- 1) Cold steel plate wholly molded surface.
- 2) Integrated stamping frame and treated with electrostatic spraying, anti-aging and anti-rust
- 3) PE head and foot board, longer automatic lifting railing, safe and reliable, and can be fixed upward and downward.
- 4) 2pcs electro-motor, 1pc control box,
- 5) One set of handset
- 6) 5" universal castors
- 7) Max Loading: 280 Kg
- 8) Battery back up



## (c) Two function electric bed SMB-2021



### Option:

- ※ UPS
- ※ 1 telescopic dining board
- ※ Dust cover 1

### Function:

- Back section up&down
- Knee section up&down

Size 2160x980x500mm(LxWxH)  
CBM 1.0

### Standard device:

- 1Pair head and foot boards
- 4Pcs European style length bedside rails
- 2Pcs motors
- 1Pc handset
- 2Pcs angle display devices
- 4Pcs 5" central locking castors
- 2Pcs braking pedals on both sides
- 4Pcs bumpers
- 4Pcs IV drip holes
- 4Pcs drainage bag hook

## Two Function Electric Hospital Bed SMB-2022



### Dimensions:

- 1) Size: L2130 × W980 × H500mm
- 2) Angle of back section: 0 ~ 70° (± 5°)
- 3) Angle of leg section: 0 ~ 30° (± 5°)

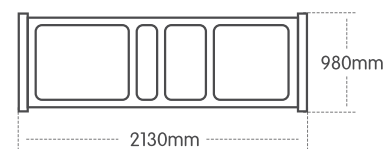

### Accessories:

- 1) I.V. pole
- 2) Wheels
- 3) Aluminum alloy protective railing

### Features:

- 1) Cold steel plate wholly molded surface.
- 2) Integrated stamping frame and treated with electrostatic spraying, anti-aging and anti-rust
- 3) ABS bed head, 6 aluminum bars fence can go up and down.
- 4) 2pcs electro-motor, 1pc control box,
- 5) One set of handset
- 6) 5" universal castors
- 7) Max Loading: 280 Kg
- 8) Battery backup

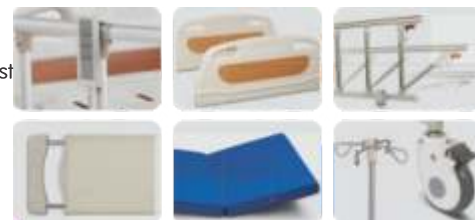

## Five function manual bed SMB-2023



### Option:

- ※ 4 New Europe Long and Long Composite Guardrails
- ※ 4Pcs European style length bedside rails

### Function:

- Back section up&down
- Knee section up&down
- The whole bed up&down
- Trendelenburg and reverse trendelenburg

Size 2220x1060x500/780mm(LxWxH)

CBM 1.0

### Standard device:

- 1Pair head and foot boards
- 4Pcs European short combination guardrail
- 4sets manual crank system
- 4Pcs angle display devices
- 4Pcs 5" central locking castors
- 2Pcs central braking padel
- 4Pcs IV drip holes
- 4Pcs drainage bag hooks

## Three function manual bed SMB-2024



Size : 2220x1060x450/740mm

### Function:

- Back section up&down
- Knee section up&down
- The whole bed up&down

### Standard device:

- 1Pair head and foot boards
- 4Pcs European style all surrounded bedside rails
- 3Pcs lead screws
- 4Pcs 5" central locking castors
- 2Pcs central braking padel
- 4Pcs IV drip holes
- 4Pcs drainage bag hooks

## Luxury three crank hospital bed SMB-2025



### Dimensions:

- 1) Size: L2180 × W1040 × H460-700mm
- 2) Angle of back section: 0 ~ 70° ( ± 5° )
- 3) Angle of leg section: 0 ~ 40° ( ± 5° )
- 4) Adjustable height: 460-700mm

### Accessories:

- 1) I.V.pole
- 2) Four center-control castors
- 3) Automatic lifting railing

### Features:

- 1) 3sets manual crank system. ABS bed head board.Cold steel plate wholly molded surface
- 2) Automatic long and short lifting guardrail, safe and reliable, and can be fixed upward and downward
- 3) Four truckles adopt central control system, which is stable and reliable, 2pcs urine hooks, 6pcs IV drip holes
- 4) Integrated stamping frame and treated with electrostatic spraying, anti-aging and anti-rust
- 5) Max Loading: 280 Kg

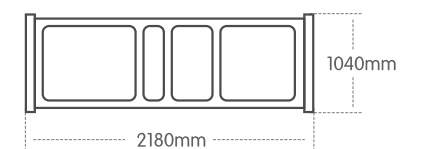

## Three function manual bed SMB-2026



Size : 2160x980x450/740mm



### Function:

- Back section up&down
- Knee section up&down
- The whole bed up&down

### Standard device:

- 1Pair head and foot boards
- 4Pcs European style all surrounded bedside rails
- 3Pcs lead screws
- 4Pcs 5" central locking castors
- 2Pcs central braking padel
- 4Pcs IV drip holes
- 4Pcs drainage bag hooks

## Three crank hospital bed SMB-2027



### Dimensions:

- 1) Size: L2130 × W980 × H480-720mm
- 2) Angle of back section: 0 ~ 70° ( ± 5° )
- 3) Angle of leg section: 0 ~ 30° ( ± 5° )
- 4) Adjustable height: 480-720mm

### Accessories:

- 1) I.V.pole
- 2) Wheels
- 3) Aluminum alloy protective railing

### Features:

- 1) 3sets manual crank system
- 2) ABS bed head, 6 aluminum bars fence can go up and down.
- 3) 4pcs soft crashworthy bumpers
- 4) accessories:5" universal castors ,2pcs urine hooks, 6pcs IV drip holes
- 5) Integrated stamping frame and treated with electrostatic spraying, anti-aging and anti-rust
- 6) Max Loading: 280 Kg

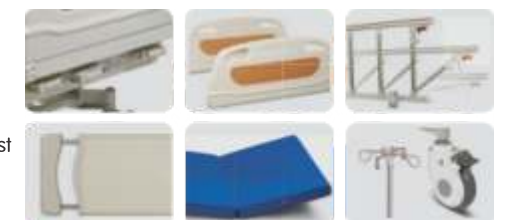
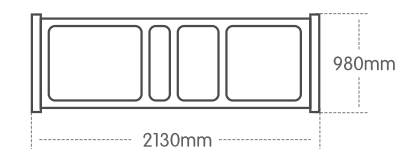



## Extra low three crank hospital bed SMB-2028



### Dimensions:

- 1) Size: L2130 × W980 × H320–620mm
- 2) Angle of back section: 0 ~ 70° ( ± 5° )
- 3) Angle of leg section: 0 ~ 30° ( ± 5° )
- 4) Adjustable height: 320–620mm

### Accessories:

- 1) I.V. pole
- 2) Wheels
- 3) Aluminum alloy protective railing

### Features:

- 1) 3sets manual crank system
- 2) ABS bed head, 6 aluminum bars fence can go up and down.
- 3) 4pcs soft crashworthy bumpers
- 4) accessories: 5" universal castors ,2pcs urine hooks, 6pcs IV drip holes
- 5) Integrated stamping frame and treated with electrostatic spraying, anti-aging and anti-rust
- 6) Max Loading: 280 Kgs

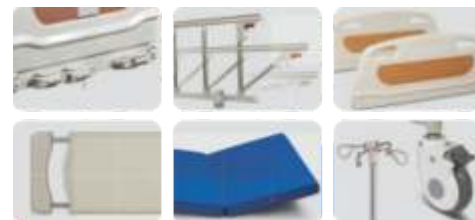
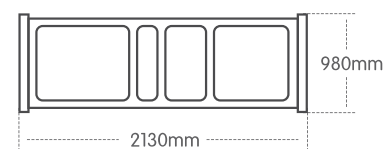

## Three function manual bed SMB-2029



Size : 2150x980x450/740mm

### Function:

- Back section up&down
- Knee section up&down
- The whole bed up&down

### Standard device:

- 1Pair head and foot boards
- 1Pair aluminum side rails
- 3Pcs lead screws
- 4pcs 5" centrallocking castors
- 1Pc central lock brake pedal
- 4Pcs IV drip holes
- 4Pcs drainage bag hooks

## Two function manual bed SMB-2030



Size : 2160x980x500mm



### Option:

※ Head and tail plate of anti-collision wheel bed

※ Rotary guardrail 1 pair

### Function:

- Back section up&down
- Knee section up&down

### Standard device:

- 1Pair head and foot boards
- 1Pair aluminum side rails
- 2Pcs Lead screws
- 4Pcs 5" central locking castors
- 2Pcs braking pedals on both sides
- 4Pcs IV drip holes
- 4Pcs drainage bag hooks
- 1Pc shoe shelf

## Two crank hospital bed SMB-2031



### Dimensions:

- 1) Size: L2160 x W980 x H500mm
- 2) Angle of back section: 0 ~ 70° (± 5°)
- 3) Angle of leg section: 0 ~ 30° (± 5°)

### Accessories:

- 1) I.V.pole
- 2) Wheels
- 3) Aluminum alloy protective railing
- 4) Oddment hook

### Features:

- 1) Double manual crank system
- 2) ABS bed head, 6 aluminum bars fence can go up and down.
- 3) accessories: 5" universal castors, 2pcs urine hooks, 6pcs I.V drip holes, 1 I.V pole
- 4) Integrated stamping frame and treated with electrostatic spraying, anti-aging and anti-rust
- 5) Max Loading: 280 Kg

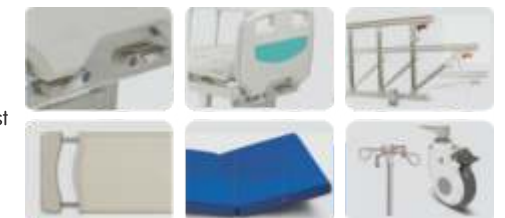
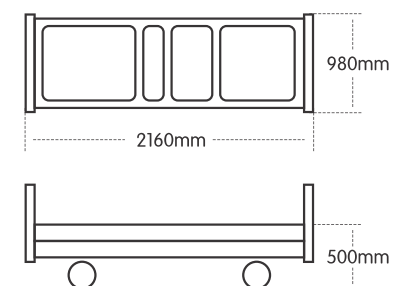

**Two function manual bed**  
SMB-2032



Size : 2160x980x500mm



**Function:**

- Back section up&down
- Knee section up&down

**Standard device:**

- 1Pair head and foot boards
- 1Pair aluminum side rails
- 2Pcs Lead screws
- 4Pcs 5" central locking castors
- 1Pc pedal in the middle
- 4Pcs IV drip holes
- 4Pcs drainage bag hooks
- 1Pc shoe shelf

**Two function manual bed**  
SMB-2033



Size : 2220x1060x500mm



**Option:**

- ※ 4 New Europe Long and Long Composite Guardrails
- ※ 4Pcs European style length bedside rails
- ※ Cover under the bed

**Function:**

- Back section up&down
- Knee section up&down

**Standard device:**

- 1Pair head and foot boards
- 4Pcs European short combination guardrail
- 2Pcs lead screws
- 4Pcs 5" central locking castors
- 2Pcs braking pedals on both sides
- 4Pcs IV drip holes
- 4Pcs drainage bag hooks
- 1Pc shoe shelf

## Two crank hospital bed SMB-2034



### Dimensions:

- 1) Size: L2160 × W1040 × H500mm
- 2) Angle of back section: 0 ~ 70° (± 5°)
- 3) Angle of leg section: 0 ~ 30° (± 5°)

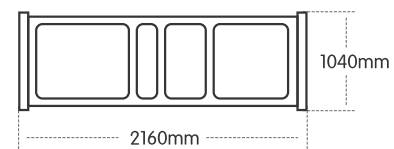

### Accessories:

- 1) I.V. pole
- 2) Wheels
- 3) Aluminum alloy protective railing
- 4) Oddment hook

### Features:

- 1) Double manual crank system
- 2) Streamline bed headboard and banister made of PE.
- 3) Four wheels adopt central control system, which is stable and reliable.
- 4) Integrated stamping frame and treated with electrostatic spraying, anti-aging and anti-rust
- 5) Max Loading: 280 Kg

## Two crank hospital bed SMB-2035



### Dimensions:

- 1) Size: L2130 × W1020 × H500mm
- 2) Angle of back section: 0 ~ 70° (± 5°)
- 3) Angle of leg section: 0 ~ 30° (± 5°)

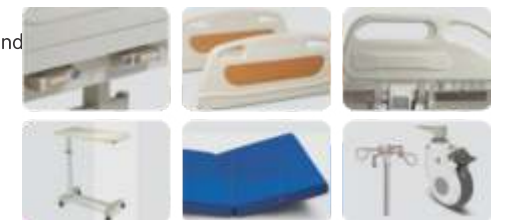
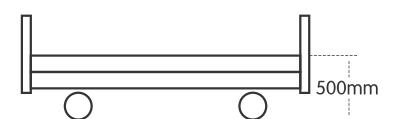
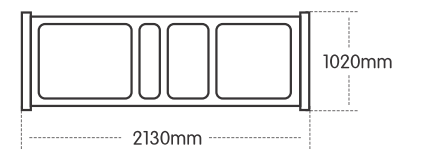

### Accessories:

- 1) I.V. pole
- 2) Wheels
- 3) Automatic lifting guardrail
- 4) Oddment hook

### Features:

- 1) Double manual crank system
- 2) ABS bed head, Automatic lifting guardrail, safe and reliable, and can be fixed upward and downward
- 3) 5" universal castors
- 4) 4pcs soft crashworthy bumpers, 2pcs urine hooks, 6pcs IV drip holes
- 5) Integrated stamping frame and treated with electrostatic spraying, anti-aging and anti-rust
- 6) Max Loading: 280 Kg

**Two function manual bed**  
SMB-2036



Size : 2160x980x500mm



**Option:**

- Japanese style bed tail
- Instrument rack

**Function:**

- Back section up&down
- Knee section up&down

**Standard device:**

- 1Pair head and foot boards
- 1pair aluminum side rails
- 2Pcs lead screws
- 4Pcs 5" deluxe castors with individual brake
- 4Pcs IV drip holes
- 4Pcs drainage bag hooks
- 1pc shoe shelf

**One function manual bed**  
SMB-2037



Size : 2150x980x500mm



**Function:**

- Back section up&down
- Knee section up&down

**Standard device:**

- 1Pair head and foot boards
- 1Pair Rotating Aluminum Full Gold Guardrail
- 2Pcs Lead screws
- 4Pcs 5" central locking castors
- 4Pcs IV drip holes
- 4Pcs drainage bag hooks
- 1Pc shoe shelf

## One crank hospital bed SMB-2038



### Dimensions:

- 1) Size: L2130 x W1040 x H500mm
- 2) Angle of back section: 0 ~ 80° (± 5°)

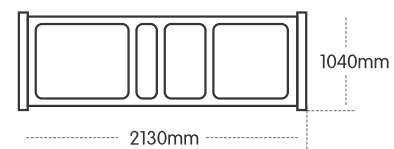

### Accessories:

- 1) I.V. pole
- 2) Wheels
- 3) Steel protective railing

### Features:

- 1) Single manual crank system
- 2) ABS bed head, 6 steel bars fence can go up and down.
- 3) 4pcs soft crashworthy bumpers
- 4) Accessories: 5" universal castors, 2pcs urine hooks, 6pcs IV drip holes
- 5) Integrated stamping frame and treated with electrostatic spraying, anti-aging and anti-rust



## One crank hospital bed SMB-2039



### Dimensions:

- 1) Size: L2160 x W980 x H500mm
- 2) Angle of back section: 0 ~ 70° (± 5°)

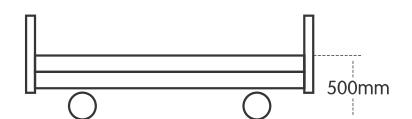
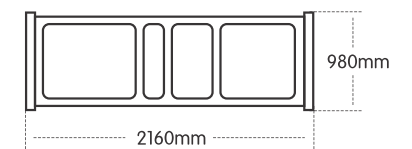

### Accessories:

- 1) I.V. pole
- 2) Wheels
- 3) Aluminum alloy protective railing
- 4) Oddment hook

### Features:

- 1) Single manual crank system
- 2) ABS bed head, 6 aluminum bars fence can go up and down.
- 3) 4pcs soft crashworthy bumpers
- 4) accessories: 5" universal castors, 2pcs urine hooks, 6pcs I.V drip holes, 1 I.V pole
- 5) Integrated stamping frame and treated with electrostatic spraying, anti-aging and anti-rust
- 6) Max Loading: 280 Kg

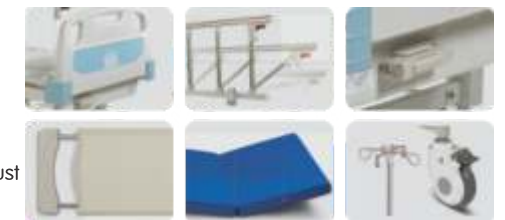

**(e) Three function electric bed**  
SMB-2040



Size 2220x1030x500 (LxWxH)



**Option:**

※ UPS

**Function:**

- Back section up&down
- Knee section up&down
- The whole bed stand up

**Standard device:**

- 1Pair head and foot boards
- 4Pcs European short combination guardrail
- 3Pcs motors
- 1Pc handset
- 4Pcs 5" central locking castors
- 4Pcs bumpers
- 4Pcs IV drip holes
- 4Pcs drainage bag hook

**Five function electric bed**  
SMB-2041



Size : 2110x1200x350/630mm



**Option:**

※ UPS

※ Steel guardrail

**Function:**

- Back section up&down
- Knee section up&down
- The whole bed up&down
- Trendelenburg and reverse trendelenburg

**Standard device:**

- 1Pair wood head and foot boards
- 1Pair wood side rails
- 4Pcs motors
- 1Pc handset
- 4Pcs 4" deluxe castors with individual brake

## Three function electric bed SMB-2042



Size : 2110x1200x350/630mm

### Option:

※ UPS

### Function:

- Back section up&down
- Knee section up&down
- The whole bed up&down

### Standard device:

- 1Pair head and foot boards
- 1Pair European style all surrounded bedside rails
- 3Pcs motors
- 1Pc handset
- 4Pcs 5" central locking castors
- 4Pcs IV drip holes
- 4Pcs drainage bag hook

## Electric home care bed SMB-2043



### Dimensions:

- 1) Size: L2080 X 1220 X400-600mm
- 2) Angle of back section: 0 ~ 70° (± 5° )
- 3) Angle of leg section: 0 ~ 30° (± 5° )
- 4) Adjustable height: 400-600mm

### Accessories:

- 1) I.V pole
- 2) Wheels
- 3) Aluminum alloy protective railing

### Functions:

- 1) 3pcs electro-motor, 1pc control box, 1pc handset
- 2) Composite board outside, powder spray painting steel
- 3) Aluminum alloy bedside rails

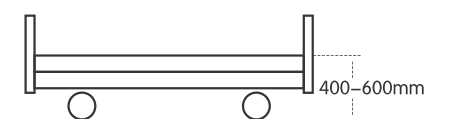
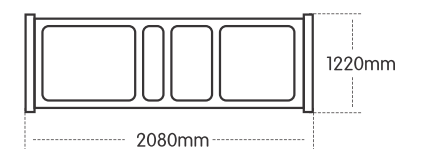



## Two crank manual Home care bed SMB-2044



### Dimensions:

- 1) Size: L2080 X 1220 X 420mm
- 2) Angle of back section: 0 ~ 70° ( ± 5° )
- 3) Angle of leg section: 0 ~ 30° ( ± 5° )

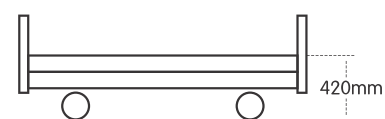
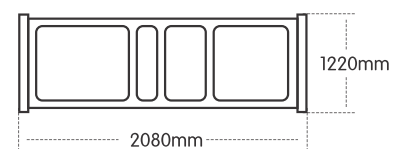

### Accessories:

- 1) I.V.pole
- 2) Aluminum alloy protective railing

### Functions:

- 1) Double manual crank system
- 2) Solid wood outside, powder spray painting steel
- 3) Aluminum alloy bedside rails

## Two function manual bed SMB-2045



Size : 2120x1020x400/450/500mm

### Standard configuration:

※ A Pair of Steel Guardrails

## Two function manual bed SMB-2046



### Standard device:

- 1Pair head and foot boards
- 1Pari European style full covering side rails
- 2Pcs lead screws
- 4Pcs 5" Luxury casters
- 4Pcs IV drip holes
- 4Pcs drainage bag hooks

### Option:

- 1pc shoe shelf
- Mosquito net rack 1 set
- Central control casters 4
- ABS Central control pedal
- Stainless steel central control pedal

### Function:

- Back section up&down
- Knee section up&down



Size : 1900× 885× 650mm

## Two function manual bed SMB-2047



Size : 1900× 885× 650mm

## Children's Bed SMB-2048



### Dimensions:

- 1) Size 1500 × 800 × 550mm
- 2) Angle of back section: 0 ~ 70° ( ± 5° )

### Features:

- 1) Single manual crank system
- 2) Frame is made of mild steel
- 3) Totally enclosed bedside rail
- 4) Bedside rail is possible to be adjusted to three altitudes

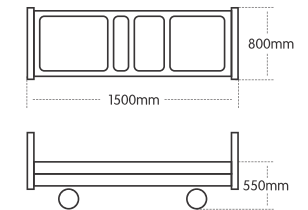

## Children's Bed SMB-2049



### Dimensions:

- 1) Size: L1800 × W900 × H600mm The whole high: 1135mm
- 2) Angle of back section: 0~80° ± ( 5° )
- 3) Angle of leg section: 0~40° ± ( 5° )

### Features:

- 1) Two manual crank system
- 2) Frame is made of mild steel
- 3) Totally enclosed bedside rail
- 4) Bedside rail is possible to be adjusted to three altitudes
- 5) The screw rod adopts the dual limit protection device

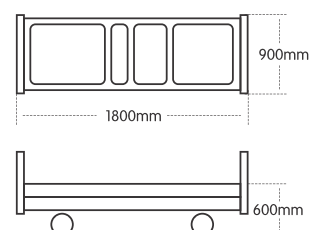

**(f) Three function electric bed**  
**SMB-2050**



**Size :** 1980× 980× 480/720mm

**Option:**

- ※ Luxury casters
- ※ 1pc shoe shelf
- ※ UPS
- ※ ABS Central control pedal

**Standard device:**

- 1Pair head and foot boards
- 1Pari European style full covering side rails
- 3Pcs motors
- Stainless steel brake
- 4Pcs 5" central locking castors
- 4Pcs IV drip holes
- 4Pcs drainage bag hooks

**Function:**

- Back section up&down
- Knee section up&down
- The whole bed up&down

**Two function manual bed**  
**SMB-2051**



**Size :** 1980x980x500mm

**Examination Bed Series**

Examination Couch with adjustable backrest  
**SMB-2052**



Size 1900×650×650mm(LxWxH)

Flat Examination Couch  
**SMB-2053**



Size 1900×650×650mm(LxWxH)

Electric Couch with rolling paper  
**SMB-2054**



Size 1900×650×650mm(LxWxH)

Electric examination Couch  
**SMB-2055**



Size 1900×650×550/800mm(LxWxH)

S.S Flat Examination Couch  
**SMB-2056**



Size 1900×650×650mm(LxWxH)

Powder coating Massage table  
**SMB-2057**



Size 1900×650×650mm(LxWxH)

# MULTIFUNCTIONAL BEDSIDE CABINET



## Bedside Cabinet Series

ABS Bedside Cabinet (Blue  
**SMC-2001**)



Size 450×460×760mm(LxWxH)  
480×480×760mm(LxWxH)  
Options: Locker, Castors

ABS Bedside cabinet (Apricot  
**SMC-2002**)



Size 450×460×760mm(LxWxH)

ABS Bedside Cabinet (Green  
**SMC-2003**)



Options: Locker, Castors  
Size 450×460×760mm(LxWxH)

ABS Bedside cabinet  
**SMC-2004**



Size 450×460×760mm(LxWxH)

## Bedside Cabinet Series

Steel Bedside Cabinet  
**SMC-2005**



Size 470×450×880mm(LxWxH)

Steel Bedside Cabinet  
**SMC-2006**



Size 460×440×780mm(LxWxH)

Wooden Bedside Cabinet  
**SMC-2007**



Size 480×480×760mm(LxWxH)

Stainless Steel Bedside Cabinet  
**SMC-2008**



Size 400×420×760mm(LxWxH)

Baby cabinet  
**SMC-2009**

Baby cabinet in carbon steel material and bassinette in Acrylic plastic.  
Size:L820\*W550\*H900mm  
Can be made as assembling



Size : 800x480x900mm



Baby cabinet  
**SMC-2010**

Baby cabinet in stainless steel material and bassinette in Acrylic plastic.  
Size: L800 × W480 × H880mm  
Can be made as CKD



Baby cabinet  
**SMC-2011**

Baby cabinet in stainless steel material and bassinette in Acrylic plastic.  
Size:L840 x W480 x H880mm  
Can be made as CKD



Size : 800x480x900mm



# PATIENT STRETCHER



## Emergency stretcher SMS-2001



### Functions:

- 1) Size: L1950 × W650 × H570/860mm
- 2) Frame is made by aluminum alloy; the surface is made by PE material.
- 3) Automatic lifting guardrail made by PE, safe and reliable, and can be fixed upward and downward.
- 4) Single crank system, hand rocker system can adjust the stretcher.
- 5) Four wheels adopt central control system, which is stable and reliable



### Dimensions:

- 1) Size: L1950 × W650 × H570/860mm
- 2) Angle of back section: 0 ~ 60° ( ± 5° )

## Emergency stretcher

SMS-2002

### Features:

- 1) The main structure made of High quality Aluminum materials
- 2) High strength alloy aluminum materials for the track, to increase steady and reliability.
- 3) The two single-stretchers can be lift up or down easily, two single-stretchers can be connecting at the same level. The bed frame can move on the 2 stretchers
- 4) At the bed side of any single stretcher can be locked automatically; and has a insurance equipment.
- 5) Central control braking system in every single-stretcher, reliable and steady during the movement or connection

### Dimensions:

- 1) Size: L3650 × W640 × H640/920mm
- 2) Angle of back section: 0 ~ 60° ( ± 5° )
- 3) Adjustable height: 640-920mm



## Stainless Steel Stretcher

SMS-2003



Material: stainless steel  
Stainless steel rail can up and down  
Bed frame can be separated  
Can be made as assembling  
Size: L1935 × W570 × H650mm

### Stretcher Serials

Aluminum stretcher in Ambulance Car

Size 2000×660×310mm(LxWxH)

SMS-2004



## Patient Stretcher SMS-2005



### Features:

Size: 1935 x 570 x 750mm

- 1) 2 section: adjustable head section and fixed trunk section with mattress
- 2) Head section is adjusted by manual rack mechanism
- 3) Frame is made of tubular stainless steel
- 4) Fitted with 4 anti-shock resin bumpers, one at each corner
- 5) Water proof mattress cover, high dense sponge inside
- 6) with multiple drainage bag hooks at each side
- 7) Positions for I.V pole
- 8) Fitted with 1 storage basket and 1 oxygen cylinder carrier
- 9) Mounted on 4 anti-static swivel castors, diameter 12.5cm with brakes

## Three Function Stretcher SMS-2006



### Dimensions:

- 1) Size: 1950\*700\*550/750mm
- 2) Angle of back section: 0° ~ 70° (± 5°)
- 3) Angle of leg section: 0° ~ 30° (± 5°)
- 4) Adjustable height :550-750mm

### Accessories:

1. I.V pole
2. mattress
3. aluminum alloy protective railing.
4. oxygen bottle holder

### Features:

- 1) Stainless steel body and mild steel powder coated holder
- 2) 3sets manual crank system
- 3) 5 aluminum bars fence can easy go up and down.
- 4) Water proof mattress cover, PU surface , high dense sponge inside
- 5) Fitted with 1 storage shelf and 1 oxygen cylinder carrier
- 6) Four pcs 5" universal castors (2pcs with brake,2pcs without), diameter 12.5cm.





# MEDICAL CHAIR



## Wheelchair Serials

Wheel Chair  
Size 930×650×880mm(LxWxH)  
**SMW-2001**



## Wheelchair Serials

Wheel Chair  
Size 1160×630×1200mm(LxWxH)  
**SMW-2002**



## Wheelchair Serials

Powder coating adjustable wheel chair  
Size 630×1280×490,270mm(LxWxH)  
**SMW-2003**



## IV drip chair SMW-2005



### Features:

- 1) Both sitting and laying positions
- 2) Imitation leather material
- 3) High dense sponge
- 4) Device: 1pc oddment basket
- 5) Size: 630 × 670 × 1200mm

## Wheelchair Serials

Commode Wheelchair  
Size 800×580×900mm(LxWxH)  
**SMW-2004**



## Nursing chair SMW-2008



### Features:

- 1) Powder spray painting steel framework
- 2) Waterproof & wearable cloth
- 3) High dense sponge
- 4) Expanding length1900mm
- 5) Size: 690 × 700 × 950mm

**SMW-2006**



**Standard device:**

- leather
  - Infusion stand
- Size : 1900x700x620mm

**SMW-2007**



Size : 760x620x430/920mm  
1860x620x430mm

**Standard device:**

- flannel
- Option:**
- ✘ leather
  - ✘ Wooden handrail

# MEDICAL TROLLEY

## Medical Trolley Serials

### Two function baby trolley SMT-2001

**Function:**

- The whole bed up&down
- Trendelenburg and reverse trendelenburg

**Standard device:**

- 4pcs 4" deluxe castors with individual brake



Size : 885x510x795/960mm



### One function baby trolley SMT-2002

**Option:**

- ※ 1PC mosquito net frame
- ※ 1PC infusion stand
- ※ 1sheets of mattress



Size : 800x480x900mm



### Two function baby trolley SMT-2003

**Function:**

- Trendelenburg and reverse trendelenburg

**Standard device:**

- 4Pcs4" deluxe castors with individual brake
- 1PC baby basin



Size : 800x480x900mm



## Medical Trolley Serials

### SMT-2004

ABS Trolley (Single Drawer)

Size 710×460×910mm(LxWxH)  
610×370×830mm(LxWxH)



## Medical Trolley Serials

### SMT-2005

ABS Trolley (Two Drawers)

Size 710×460×950mm  
610×370×830mm



### SMT-2006

ABS Trolley(One drawer)

Size 650×460×950mm(LxWxH)  
610×370×830mm(LxWxH)



### SMT-2007

S.S. Transport Trolley

Size 900×600×800mm(LxWxH)



### SMT-2008

S.S. Emergency Cart Type I

Size 650×420×850mm(LxWxH)



### SMT-2009

S.S. Emergency Cart Type II

Size 650×420×850mm(LxWxH)



## Medical Trolley Serials

S.S. Two-shelf Transport Trolley  
Size 900×500×800mm(LxWxH)  
**SMT-2010**



S.S. Hot Water Transport Trolley  
Size 870×544×800mm(LxWxH)  
**SMT-2011**



S.S. Dirty Linen Trolley  
Size 550×550×800mm(LxWxH)  
**SMT-2012**



S.S. Clean Linen Trolley  
Size 930×480×900mm(LxWxH)  
**SMT-2013**



S.S. Dirty Linen Trolley  
Size 550×550×800mm  
**SMT-2014**



Steel Clean Linen Trolley  
Size 1185×570×960mm(LxWxH)  
**SMT-2015**



## Medical Trolley Serials

S.S. Two Shelf Trolley  
Size 700×450×800+80mm(L)  
650×420×800+80mm(M)  
500×400×800+80mm(S)  
**SMT-2016**



S.S. Three shelf Trolley  
Size 650×420×800+80mm  
**SMT-2017**



S.S. Scalloped Trolley  
Size 1400×450×800+80mm  
**SMT-2018**



S.S. Transport Trolley  
Size 1000×700×900mm(LxWxH)  
**SMT-2019**



S.S. Treatment Trolley(Two Drawers)650  
Size 700×450×800+80mm(L)  
×420×800+80mm(M)  
**SMT-2020**



S.S. Cleaning Trolley  
Size 500×400×800mm(LxWxH)  
**SMT-2021**



## Medical Trolley Serials

S.S. Medicine Trolley(Two Drawers)  
Size 600×450×800mm(LxWxH)  
**SMT-2022**



S.S. Dressing Trolley  
Size 640×420×800+80mm(LxWxH)  
**SMT-2023**



S.S. Transport Trolley  
Size 800×500×200mm(LxWxH)  
**SMT-2024**



S.S. Surgical Trolley  
Size 450×350×800/1300mm  
**SMT-2025**



ABS Trolley  
Size 710×460×910mm(LxWxH)  
610×370×830mm(LxWxH)  
**SMT-2026**



ABS Trolley  
Size 710×460×910mm(LxWxH)  
610×370×830mm(LxWxH)  
**SMT-2027**



## Medical Trolley Serials

ABS Emergency Cart  
Size 625×475×930mm(LxWxH)  
**SMT-2028**



ABS Emergency Cart  
Size 625×475×930mm(LxWxH)  
**SMT-2029**



ABS Medicine Trolley  
Size 625×475×930mm(LxWxH)  
673×480×960mm(LxWxH)  
**SMT-2030**



ABS Ward Round Trolley  
Size 850×480×930mm(LxWxH)  
**SMT-2031**



ABS Medicine Trolley  
Size 750×475×930mm(LxWxH) S  
850×520×960mm(LxWxH) L  
**SMT-2032**



S.S. Emergency Cart Type II  
ABS Infusion Trolley  
Size 625×475×930mm(LxWxH) S  
673×480×960mm(LxWxH) L  
**SMT-2033**



## Medical Trolley Serials

ABS Anaesthesia Trolley  
 Size 625×475×930mm(LxWxH)  
**SMT-2034**



ABS Treatment Trolley  
 Size 750×475×920mm(LxWxH) (S)  
 850×520×950mm(LxWxH) L  
**SMT-2035**



ABS Medicine Trolley  
 Size 625×475×930mm(LxWxH)  
**SMT-2036**



ABS Emergency Cart  
 Size 850×520×990mm(LxWxH)  
**SMT-2037**



Morning Nursing Trolley  
 Size 800×590×890mm(LxWxH)  
**SMT-2038**



Morning Nursing Trolley  
 Size 1185×570×936mm(LxWxH)  
**SMT-2039**



## Medical Trolley Serials

ABS Treatment Trolley  
 Size 650×480×980mm(LxWxH)  
**SMT-2040**



ABS Infusion Trolley  
 Size 850×520×960mm(LxWxH)  
**SMT-2041**



ABS Treatment Trolley(Two Drawer)  
 Size 720×480×890mm(LxWxH)  
**SMT-2042**



ABS Treatment Trolley One Drawer  
 Size 720×480×890mm(LxWxH)  
**SMT-2043**



S.S. Patient Record Trolley  
 Size 350/660×350×935mm(LxWxH)  
 6600×350×1085/1145/1235mm(LxWxH)  
**SMT-2044**



Patient Record Trolley  
 Size: (25 Grab) 450×410×950mm(LxWxH)  
 (50 Grab) 750×410×980mm(LxWxH)  
**SMT-2045**





# OTHER HOSPITAL NECESSITIES



**Bedside table**  
SMX-2001



Movable, can adjust the position low or high  
Can be made as assembling  
Specifications: 750 × 400 × 720–1150mm

**Bedside table**  
SMX-2002



Movable, can adjust the position low or high  
Made of ABS and aluminum alloy  
Specifications: L800 × W400 × H800–1090mm

**Bedside table**  
SMX-2003



Movable, can adjust the position low or high, made of composite board and aluminum alloy, there is a rail on the composite board  
Size: 800\*400\*750/1050

**ABS over-bed table <MDF>**  
SMX-2004



**Size : 800x400x750/1000mm**

## Over bed table SMX-2005



### Description:

- 1) ABS material injected plastic board
- 2) Aluminum alloy pull and stretch design

### Size:

L900/1060 × 350mm

## Dining table <fixed> SMX-2006

Size : 970x400x25mm



Size 980×390×45mm(LxWxH)  
**SMX-2007**



Size 750×390×45mm(LxWxH)  
**SMX-2008**



Size 2000×115×30 Single  
**SMX-2009**



Size 950×560×45mm(LxWxH)  
**SMX-2010**



Size 1020×500×25mm(LxWxH)  
**SMX-2011**



Size 1020×500×25mm  
**SMX-2012**



**Aluminum Bedside rail**  
SMX-2013



**PP bed plate**  
SMX-2018



**SMX-2019**



**Steel Bedside rail**  
SMX-2014



**Long and Short PE Bedside rail**  
SMX-2020



**PE bed head and foot board**  
SMX-2021



**I.V drip stand**  
SMX-2015



**PP Bedside rail**  
SMX-2016



**Medical record**  
SMX-2017



**ABS bed head and foot board**  
SMX-2022



**ABS High and low Bed head and foot board**  
Head board is 7cm higher than foot board  
SMX-2023



## Castors Series

Deluxe Central Lock Castor  
Size 125mm(LxWxH)

**SMX-2024**



Deluxe Individual Brake Castors  
Size 125mm(LxWxH)

**SMX-2025**



Polyester Castor  
Size:  $\varnothing$ 125mm(LxWxH)

**SMX-2026**



## Guardrails / Side Rails

Size 960×420mm(LxWxH)(Four Bars)  
**SMX-2027**



Size 1220×420mm(LxWxH)(Five Bars)  
**SMX-2028**

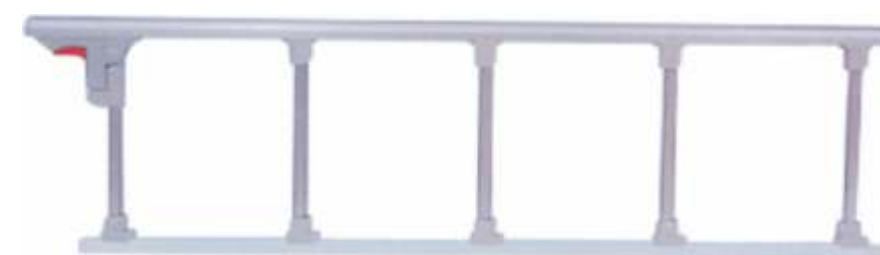

Size 1480×420mm(LxWxH)(Six Bars)  
**SMX-2029**

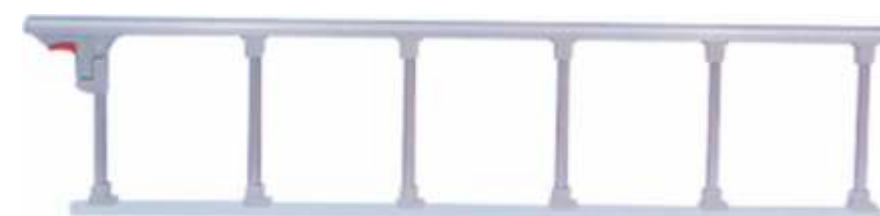

Size 1480×550×25mm(LxWxH)  
**SMX-2030**



# QUALITY FURNITURE FOR YOUR COMFORT WORKING

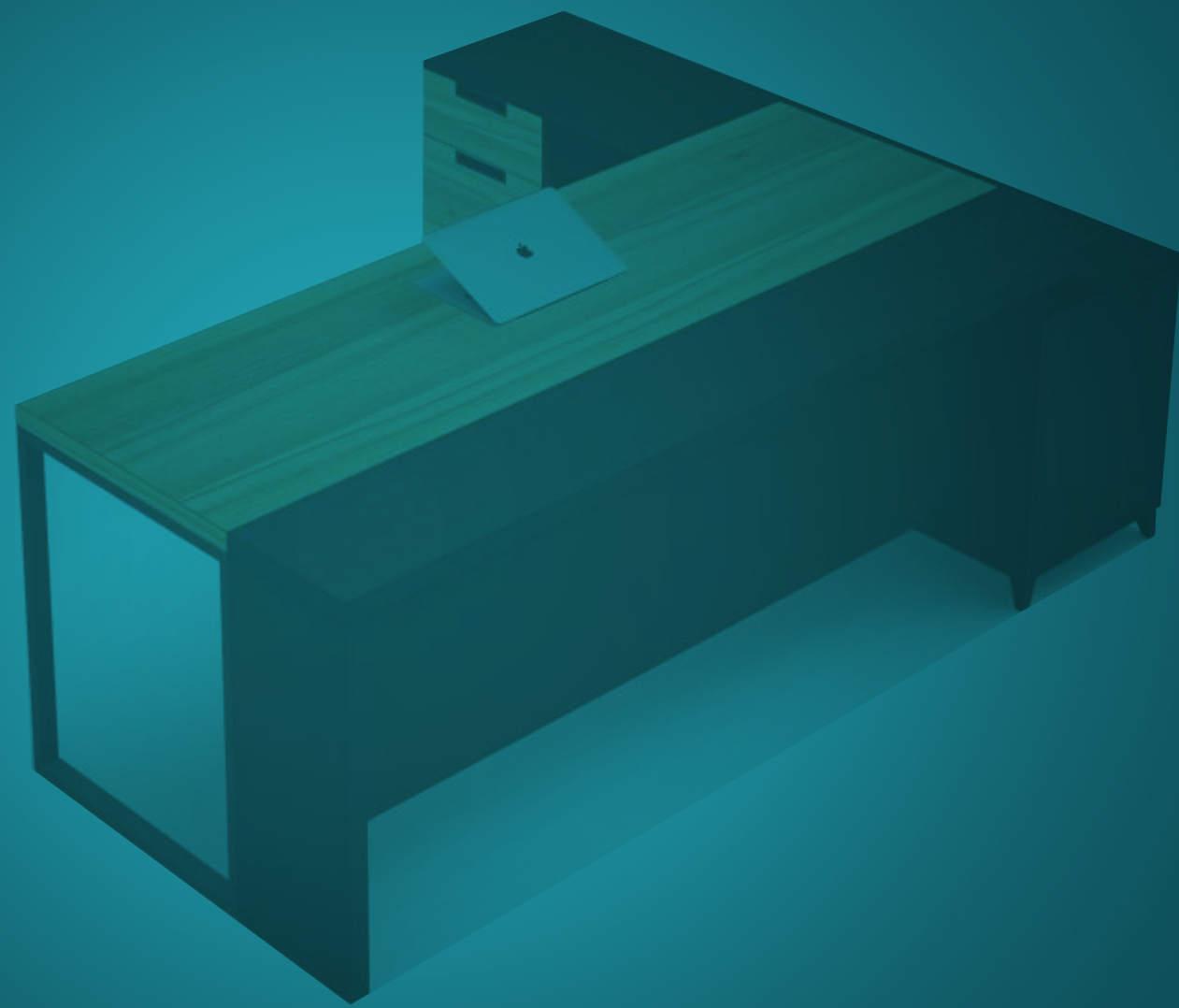

## Reception Tables



Product code  
**OZ-8C03-22**  
**OZ-8C03-20**  
**OZ-8C03-18**  
**OZ-8C03-16**

### SERENE BEAUTY!

Wooden reception desk with self styled grooves in White paint, embedded with glass work top, creative top & metal sides. Indeed an ingredient for warm reception!



Product code  
**OZ-8C01-48**  
**OZ-8C01-36**  
**OZ-8C01-32**



### CURVE LINEART!

Curve Lines offer one of the best design options for a high utility view designed furniture in office like Reception tables. This product offers a convenient workspace in the Corporate & at the same time fills the Reception space with seductive effect.



## Reception Tables

Product code  
OZ-RE02



Product code  
OZ-RE03



## Reception Tables

Product code  
OZ-1920



Product code  
OZ-1920-14  
OZ-1920-16  
OZ-1920-18



Product code  
OZ-1921-18  
OZ-1921-22  
OZ-1921-24



## Office Tables



Product code  
 OZ1202T-12  
 OZ1202T-14  
 OZ1202T-16  
 OZ1202T-18  
 OZ1202T-20



Product code  
 OZ-1201S-16  
 OZ-1201S-18  
 OZ-1201S-20  
 OZ-1201S-22



## Office Tables

Product code  
 OZ-1901-20  
 OZ-1901-22  
 OZ-1901-24



Product code  
 OZ1225T-15



Product code  
 OZ1226U-12  
 OZ1226U-14

Product code  
 OZ1226U-12  
 OZ1226U-14  
 OZ1226U-24  
 OZ1226U-28  
 OZ1226U-36  
 OZ1226U-42

Product code  
 OZ-1905-16  
 OZ-1905-18  
 OZ-1905-20  
 OZ-1905-22



## Office Tables

Product code  
OZ-1910-14  
OZ-1910-16  
OZ-1910-18  
OZ-1910-20



## Office Tables

Product code  
OZ-1907-16



Product code  
OZ-EX01



## Work Stations

Product code  
OZ-1912-12  
OZ-1912-24  
OZ-1912-36





## Work Stations

Product code  
OZ-1922-14  
OZ-1922-16



## Work Stations

Product code  
OZ-2318-4



Product code  
OZ1223S-14  
OZ1223S-16  
OZ1223S-28  
OZ1223S-32

Product code  
OZ1224S-10  
OZ1224S-12



Product code  
OZ-2350-4

Product code  
OZ-2350-1

## Work Stations



Product code  
OZ122V-12  
OZ122V-14  
OZ122V-24  
OZ122V-28  
OZ122V-36  
OZ122V-42



Still, the only thing a right-hand to demand, but it's not for the faint of heart. The design process from start to finish is a long and complex one. The designers who you request from Riva Office are the best in the industry. They have a wealth of experience and a passion for creating the most functional and beautiful office furniture in the world.

## Cabinet



Product code  
OZ-2348-L

Product code  
OZ-2348-R

## Waiting Chairs

Product code  
RF560A



Product code  
WA-58TH



Product code  
WA-59FR



## Waiting Chairs

Product code  
WA56-TH-PU



## Waiting Chairs

Product code  
WA55-TH-CU



Product code  
WA58-AR



Product code  
WA55-TH-PU

Product code  
WA57-FR



Product code  
WA3-TH-CU



## Chairs



Product code  
HT-7042A

Product code  
HT7056B



Product code  
HT-7021AF



Product code  
RF560B

## Chairs



Product code  
RF560A

Product code  
HT7072A



Product code  
RF560D



Product code  
RF571A

## Chairs



Product code  
SP-914A



Product code  
HT-7011B



Product code  
SP-910A



Product code  
HT-7068A



Product code  
RF568A



Product code  
HT-7073AF



Product code  
A1-897 -Front



Product code  
A1-897-Back

## Chairs



[www.riva-office.fr](http://www.riva-office.fr)

Rua Pomar de Marvila, Lote 13  
Parque Industrial de Sequeira  
4705-629 / Braga - Portugal

+33(0) 187 449 733  
[info@riva-office.fr](mailto:info@riva-office.fr)